



Porfyrios Doors & Partitions

Specialty Glass Applications for Commercial
and Residential Doors and Partitions

PORFYRIOS
GLASS

F1

Flush Door Series



F1 flush door series

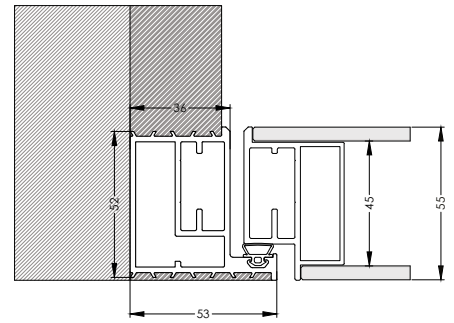

F2 flush door series

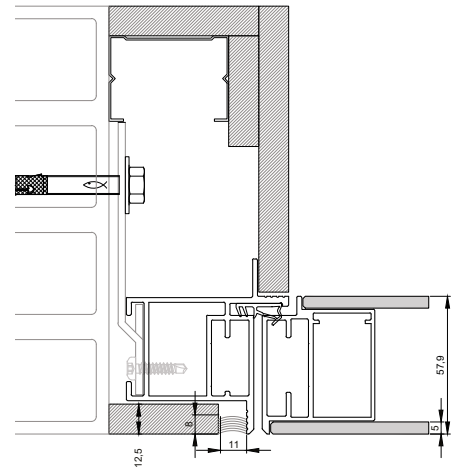

Achieve the smooth surface effect with PCA flush door series

Material range: glass, ceramic, stone, wood finish

A25
Full Frame Door Series

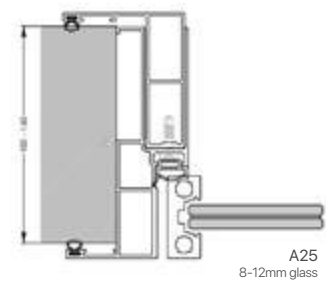
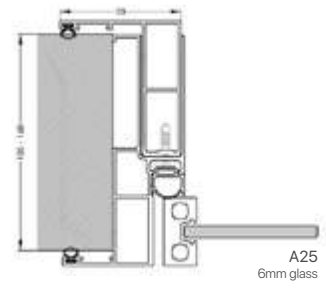

Suitable for 8-12 mm glass thickness.

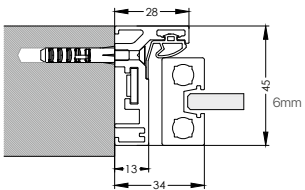

Personalize your space by selecting among the frames and glass finishes that suits best your aesthetics.



A1 | GT10 & GT09 profile

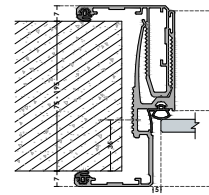

A2 | GT11 profile

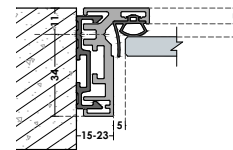

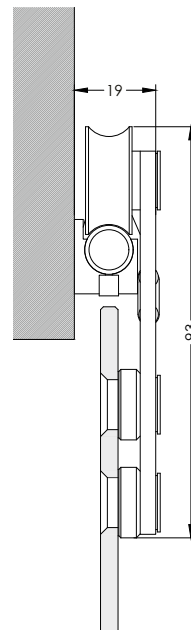

SA
Sliding Door Series

Prefer the sliding series for room optimization and give a rustic essence to your area.



D 1000

Softclose Sliding Door Series

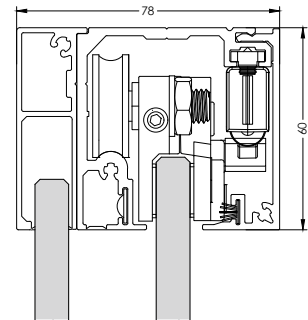
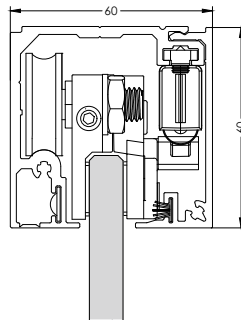



V1000
Telescopic Synchronized Door



W1

Facade Series

Welcome the transparency



V2000

Softclose Sliding System

Performing the smooth enclosure



Concealed top guide track



V3000

Softclose Sliding System



Office partitions

Single glazed office partitions.
10mm-13,52mm glass thickness

SOUNDPROOF

NEW Double glazed partition

- Opening doors
- Flush door
- Sliding door
- Door closer | Bottom drop seal

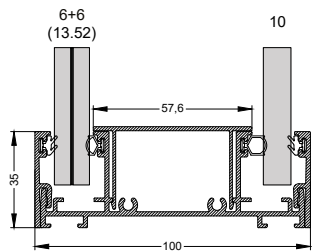

sliding door

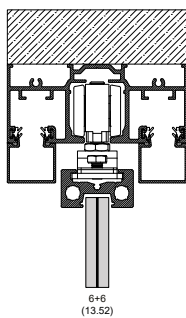

door & skylight

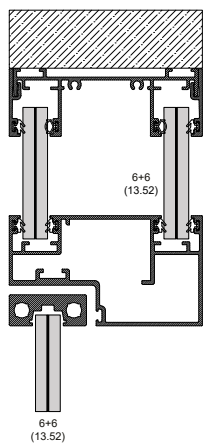



A10

Glass Partition

Make your combination through vertical and horizontal profiles knitting the grid with the glass of your choice.

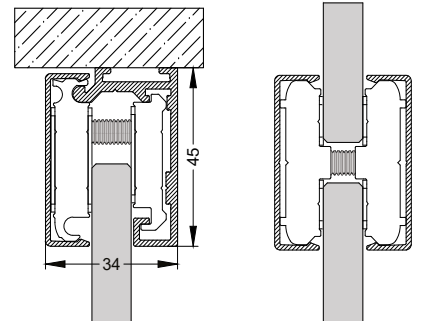

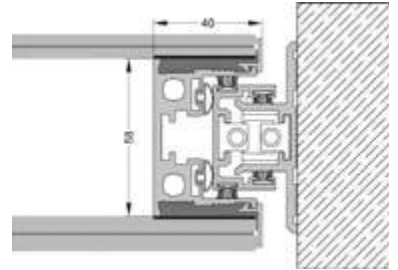
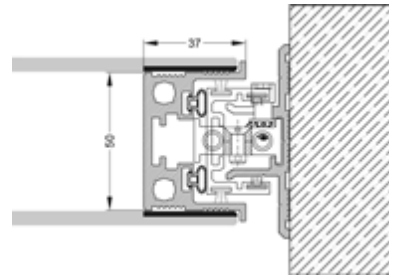

GF01
Frameless Glass Partition

Glaze the silence

Double glazed surface, concealed profiles powder coated coloring, soundproofing up to 45 db.



DR01

Folding Door Series

Movable wall, folding according to each structure standards, optimizing your space.

Perhaps the most suitable choice for commercial and private properties.



DR02

Folding Door Series

Modular glass panels.



GL1

Guillotine System

Choose the contemporary.

Electric supplied motor

Up to 3 panels

Upward or downward function.

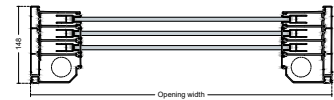
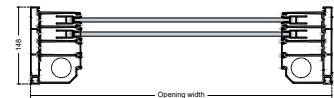
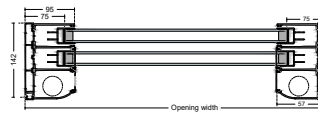
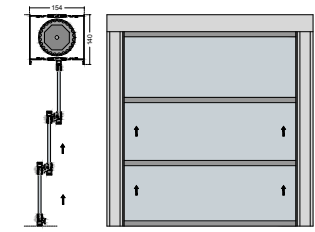
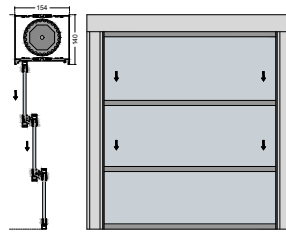
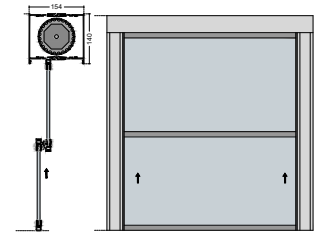
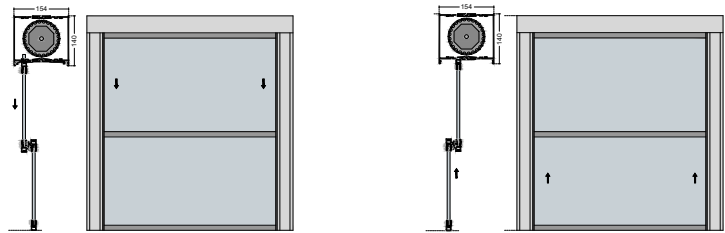
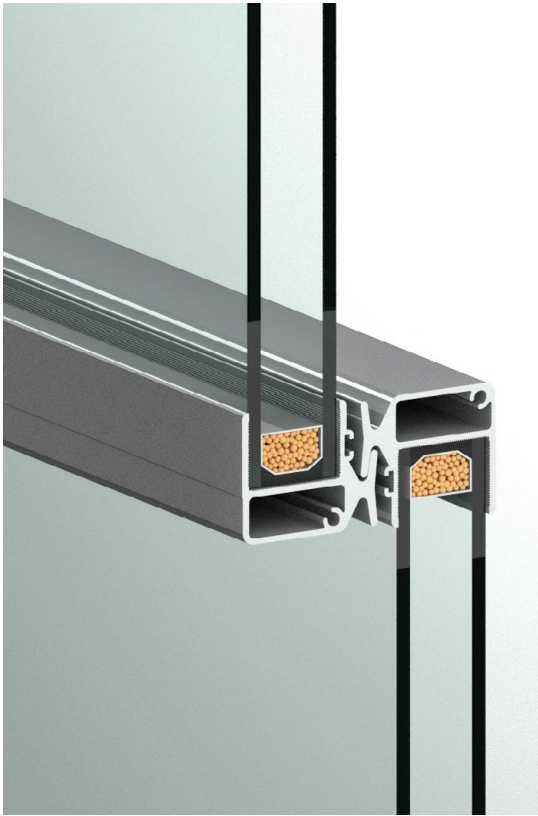

Define luxury.



A0
Shower Cabin Series



SN
Sliding Shower Cabin Series



BO
Hinged Shower Cabin Series



SA9
WC Partition Series

Unique privacy

WC / Shower cubicles

Locker rooms

Fitting rooms

PORFYRIOS **GLASS**

19, SPYROU KYPRIANOU, ERGATES INDUSTRIAL AREA, P.O.Box.28343 NICOSIA,
2093 NICOSIA-CYPRUS, TEL: +357 22 487756, FAX: +357 22 487910

Email: porfyriosglass@cytanet.com.cy

Web: www.porfyriosglass.com