

V2000 SOFTCLOSE SLIDING SYSTEM

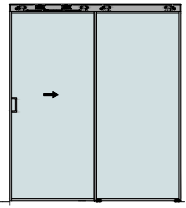

TYPOLOGIES

V2001



V2002

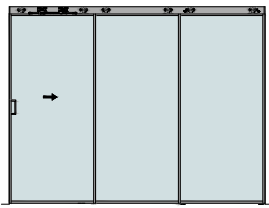

V2003

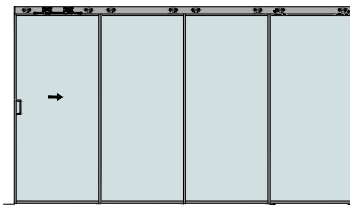

V2004

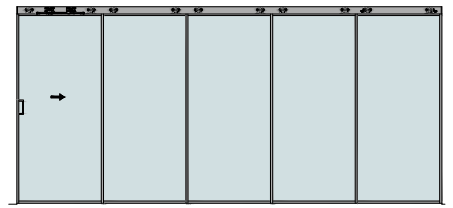

V2005

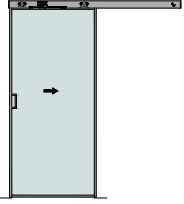

V2006

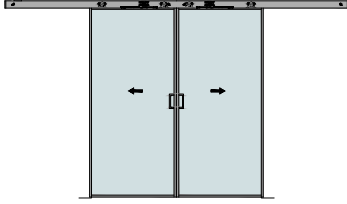

V2007

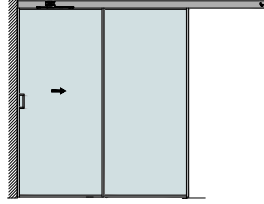

V2008

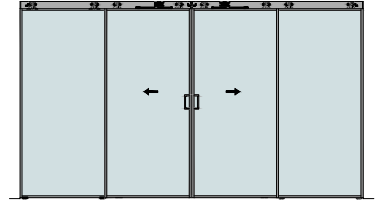

V2009

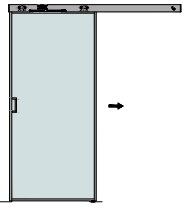

V2010

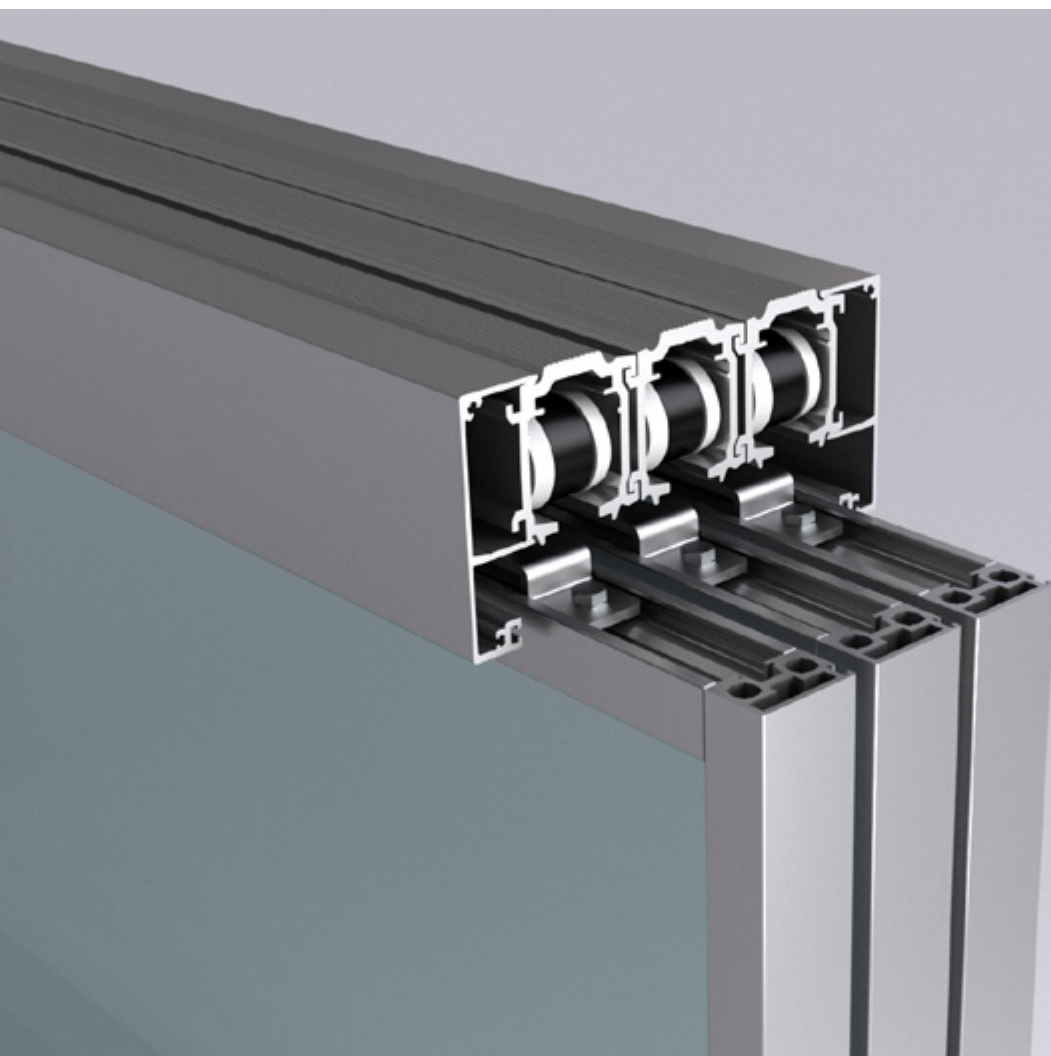
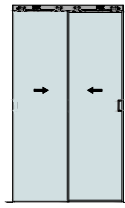

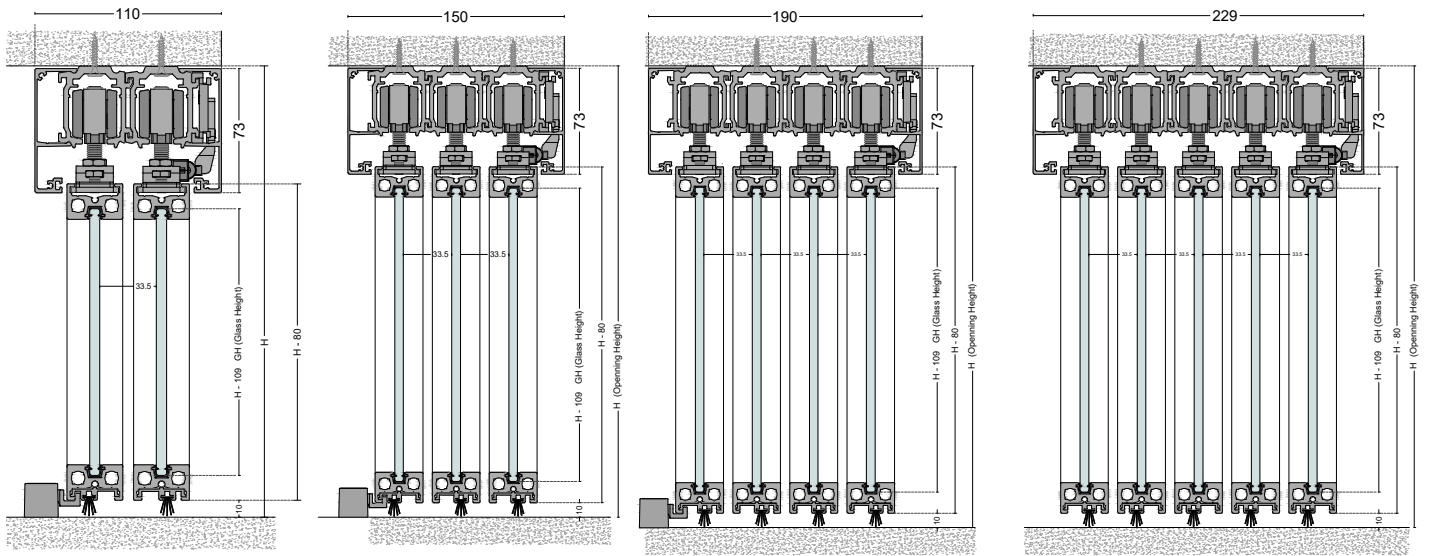

GT15-1

GT15-2

GT15-5

GT15-6

GT15-7

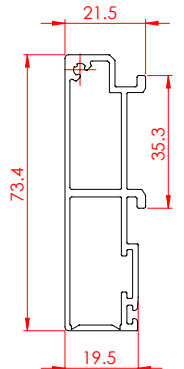
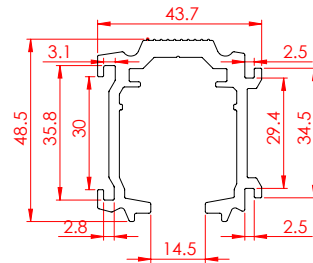
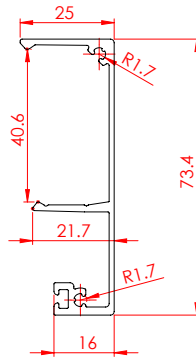
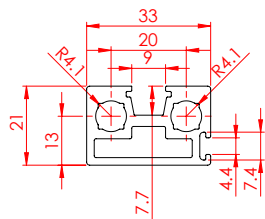
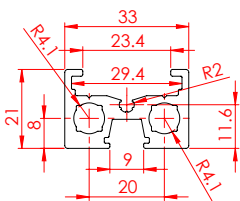

GT15-7
Material: AL 6063-T6
Weight: 921 gr/m

GT15-6
Material: AL 6063-T6
Weight: 1405 gr/m

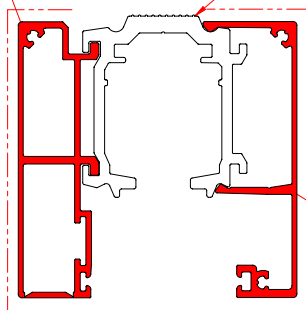

GT15-5
Material: AL 6063-T6
Weight: 668 gr/m

GT15-1
Material: AL 6063-T6
Weight: 810 gr/m

GT15-2
Material: AL 6063-T6
Weight: 890 gr/m

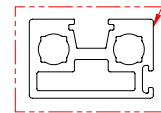
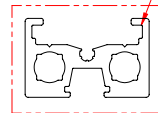

Material: Aluminium
Finish: Satin, Natural Anodize
Glass Thickness: 6mm, 8mm
Maximum Dimensions: 1000x3000, 1200x2500, 1400x2000

GLASS THICKNESS

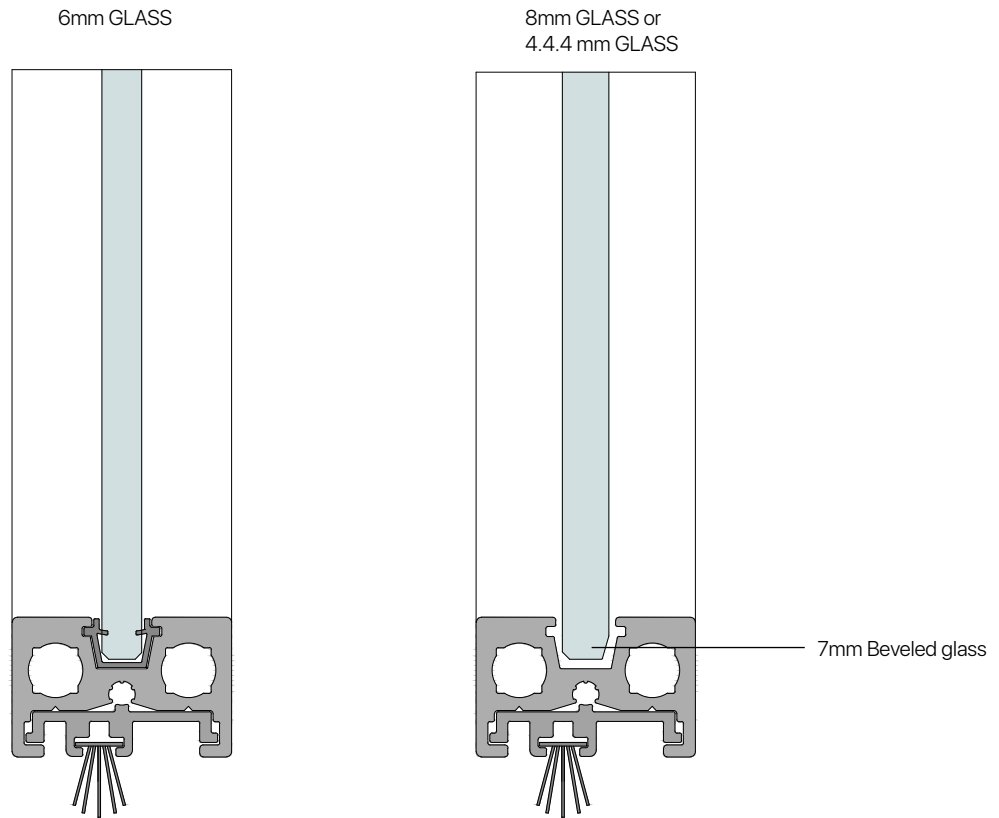

MAXIMUM PANEL DIMENSIONS

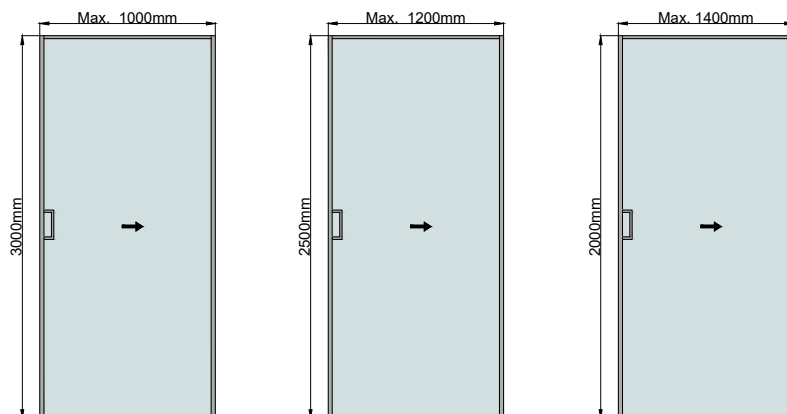

- Maximum load/roller is 60 kg

